



# **OBSERVATOR**

*instruments*



## **OMC-140 Multifunctional NMEA display**

### **Installation Manual**

**Version 1.07 2016**

Author: Observer Instruments

*Revisions:*

1.01 (January 2014)	First issue	Preliminary edition
1.02 (June 2015)		
1.03 (September 2015)		
1.04 (December 2015)	First Release	
1.05 (February 2016)	added Wind Alarm information	
1.06 (August 2016)	Update USB menu, added input retired NMEA Messages.	
1.07 (October 2016)	Reviewed version	

## Index

1	Introduction.....	5
2	Safety .....	6
3	Identification .....	7
3.1	Standard Items in the box .....	7
3.2	Optional items .....	8
3.3	Display.....	9
3.4	Option modules .....	9
3.4.1	Installation Option Modules .....	10
4	Mounting.....	11
4.1	Mounting location .....	11
4.2	Mounting position .....	11
4.3	Panel cut-out .....	11
4.4	Mounting clamps .....	11
5	Terminals.....	12
5.1	Sensor connection .....	12
5.2	Main connections .....	12
5.3	AC Connection .....	13
5.4	DC power module connections (optional) .....	13
5.5	Remote keypad and relay module (optional) .....	13
5.6	Connections .....	14
6	Commissioning .....	15
6.1	Preparations .....	15
6.2	Display Type Selection.....	15
6.3	Configuration via Touch screen .....	17
6.4	Advanced .....	17
6.4.1	Advanced password (default 1382) .....	17
6.4.2	Advanced settings.....	18
6.4.3	Front (Screen layout) .....	21
6.4.4	Enabling parameters without the actual data .....	21
6.4.5	Sensors.....	22
7	Terminal Mode Configuration .....	23
8	Terms, Abbreviations & Symbols list.....	24
8.1	Terms & Abbreviations .....	24
8.2	Symbols.....	24
9	Digital interface.....	25
9.1	NMEA software .....	25
9.1.1	Inputs: .....	25
9.1.2	Outputs: .....	25
9.2	NMEA Message description .....	26
10	NMEA Hardware:.....	30
12	Specifications.....	31
12.1	Inputs/Outputs .....	31
12.2	TFT touch screen .....	31
12.3	Electrical .....	31
12.4	Environmental specifications.....	31
12.5	Dimming possibilities.....	31
12.6	Dimensions.....	31
12.7	Alarms .....	32
12.8	In accordance with .....	32
13	Menu structure Touch screen .....	33
14	Menu Structure Terminal Mode .....	36
15	Dimensional drawings.....	40
16	Panel cut-outs .....	42
16.1	Recommended panel cut-out .....	42
16.2	Panel cut-out for retrofit 144x144 instrument.....	42
16.3	Optional Keypad panel cut-out.....	43

*Page intentionally left blank*

## 1 Introduction

This manual contains required information for installation, commissioning and integrating the OMC-140 display. For operating the display we kindly refer to the Operators' Guide and Operators' Manual.

Some information will be available in both manuals for your convenience. We do advise to keep the Operators manual at hand as well during installation.

After installation this manual should be kept by the system administrator of the system. It contains information and passwords which could affect the working of the display if used without the proper care.

## 2 Safety



**Do not open display.  
Potential lethal voltages inside.  
No user exchangeable parts inside.**



**Only use indoors.  
For outdoor use an IP66 or better housing is required.**



**For correct functioning of this display the display and connected sensors must be installed according installation instructions.**









**Remember: instruments are tools.  
They do NOT replace your own observations!**

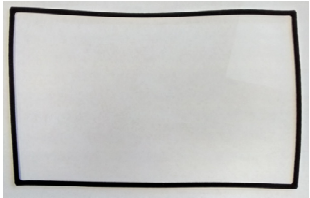
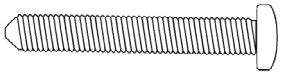

**After end of life dispose this product according local regulations or return to manufacturer.**

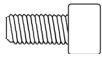
### 3 Identification

#### 3.1 Standard Items in the box

Item	pce	Description
	1	Display
	1	Seal for IP22 Panel mounting
	4	Panel mounting screw Nylon
	4	Panel mounting clamp
	4	M4 -12mm hex screw
	1	AC power connector (mounted on the display)
	2	4 Terminal connector input (mounted on the display)
	1	3 Terminal connector output (mounted on the display)

## 3.2 Optional items

1. Spacer for 144x144 (retrofit) mounting.
2. Bracket
3. Micro USB cable
4. Cleaning kit
5. 12-24 Vdc PSU module
6. Remote control panel
7. Micro SD card 2Gb
8. Power connector cable housing

### 3.3 Display

Connections are described in [chapter 5 Terminals](#)

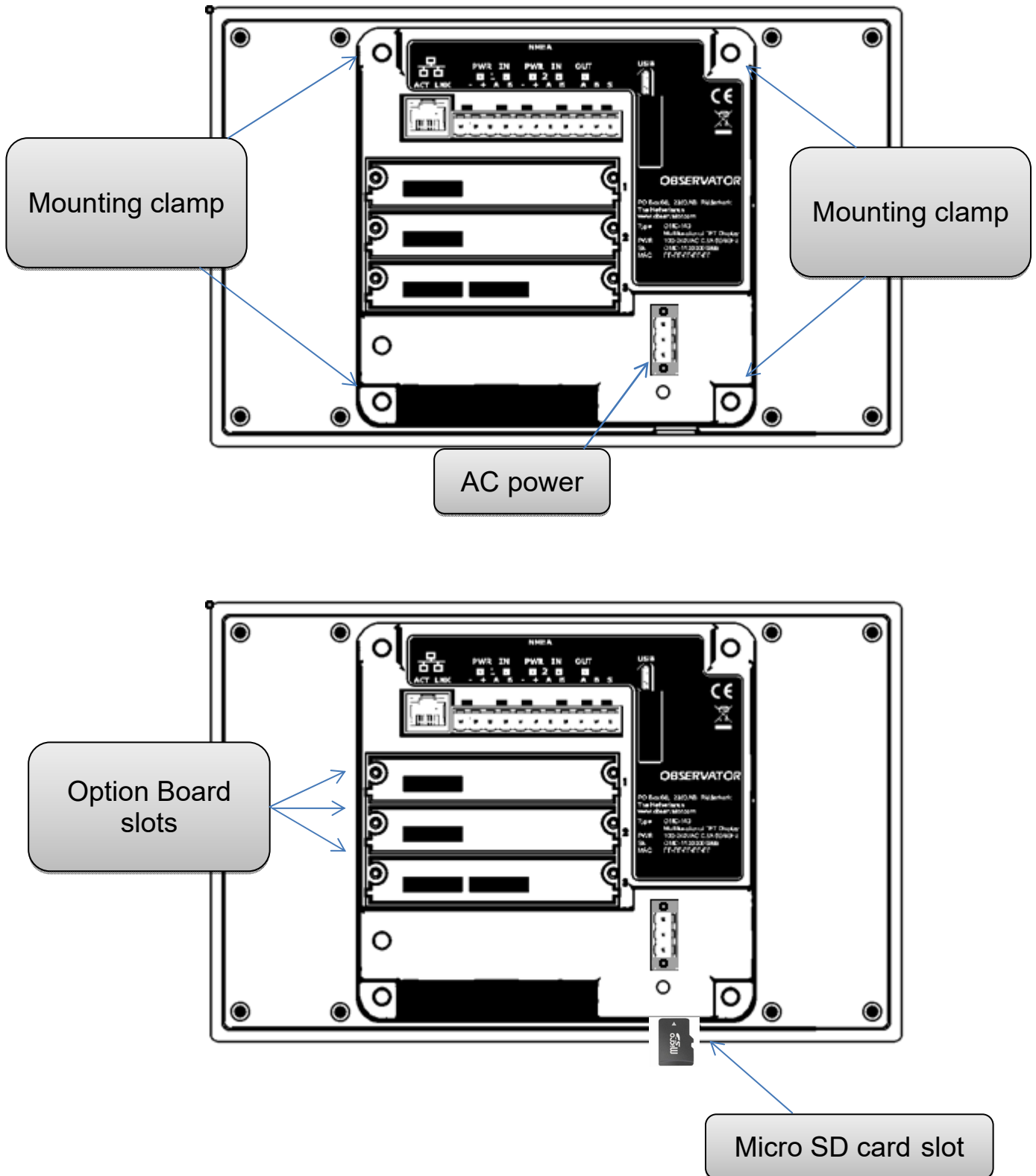

### 3.4 Option modules

If any option modules are included, install them before mounting.

The modules can be installed in any of the 3 slots, but we do recommend to place the DC power module in slot one, which is on top.

#### 3.4.1 Installation Option Modules

Beware of ESD when installing the option modules, wear an antistatic wrist belt, avoid touching any electronics on the module.

1. Remove the protection plate of the slot to be used, save the screws for locking the module later.
2. Remove package of option module
3. Position the module with the connector facing the display on the left side and carefully slide the module in the module slot.
4. Secure the module with the screws from the protection plate.

---

## 4 Mounting

### 4.1 Mounting location

Choosing the right location is important for correct functioning of the display. Please mind the following recommendations:

- Although the display has an antiglare filter it is recommended to choose a position where the display doesn't reflect direct light.
- If the operator will need to operate the display it must be in reach or the optional remote panel should be installed.
- Dimming can also be remotely controlled using the NMEA DCC message.
- Allow enough space for cabling.
- Allow enough space for service.

### 4.2 Mounting position

The display can be mounted either in Landscape (default) or Portrait position. Landscape is preferable since it allows maximum use of the display area. Portrait mode has 2 data positions less.

The display can be panel mounted, desktop or ceiling mounted. For ceiling or desktop mounting an optional bracket is available.

### 4.3 Panel cut-out

For new installations we recommend to use the large cut-out of 228x142mm. Optional the display can be fitted in the 144x144 position (cut-out 138x138mm) and optional spacer is available. This can be useful for refits (replacement of the OMC-138, 139 or 934 or any other 144 display. Cut-out drawings can be found in chapter *16 Panel cut-outs*.

**IP 22 rating only for 228x142mm panel mount with use of included seal!**

### 4.4 Mounting clamps

For the full panel mount, the clamps can be attached before the display is inserted, do not tighten them yet. For 144x114 panel mount, the display must be fitted first. Attach the claps on the position as marked in chapter 1.1 and tighten them without any force. Secure the display using the 4 Nylon screws, tighten them carefully by hand. If hard to reach a Phillips screwdriver can be used, but do not use any force.

**No force should be used to tighten the Mounting clamps and Nylon screws!**

## 5 Terminals

### 5.1 Sensor connection

The OMC-140 display has 2 isolated NMEA inputs, both with power output available. The power output have a watchdog, whenever no valid signal is received for 10s, the power will be interrupted to reset the attached sensor.

Use a NMEA multiplexer like Observator MeteoLink whenever you require more NMEA inputs. The display has 1 NMEA output.

All NMEA and Mains terminals are suitable for wires up to 2.5mm<sup>2</sup>.

### 5.2 Main connections

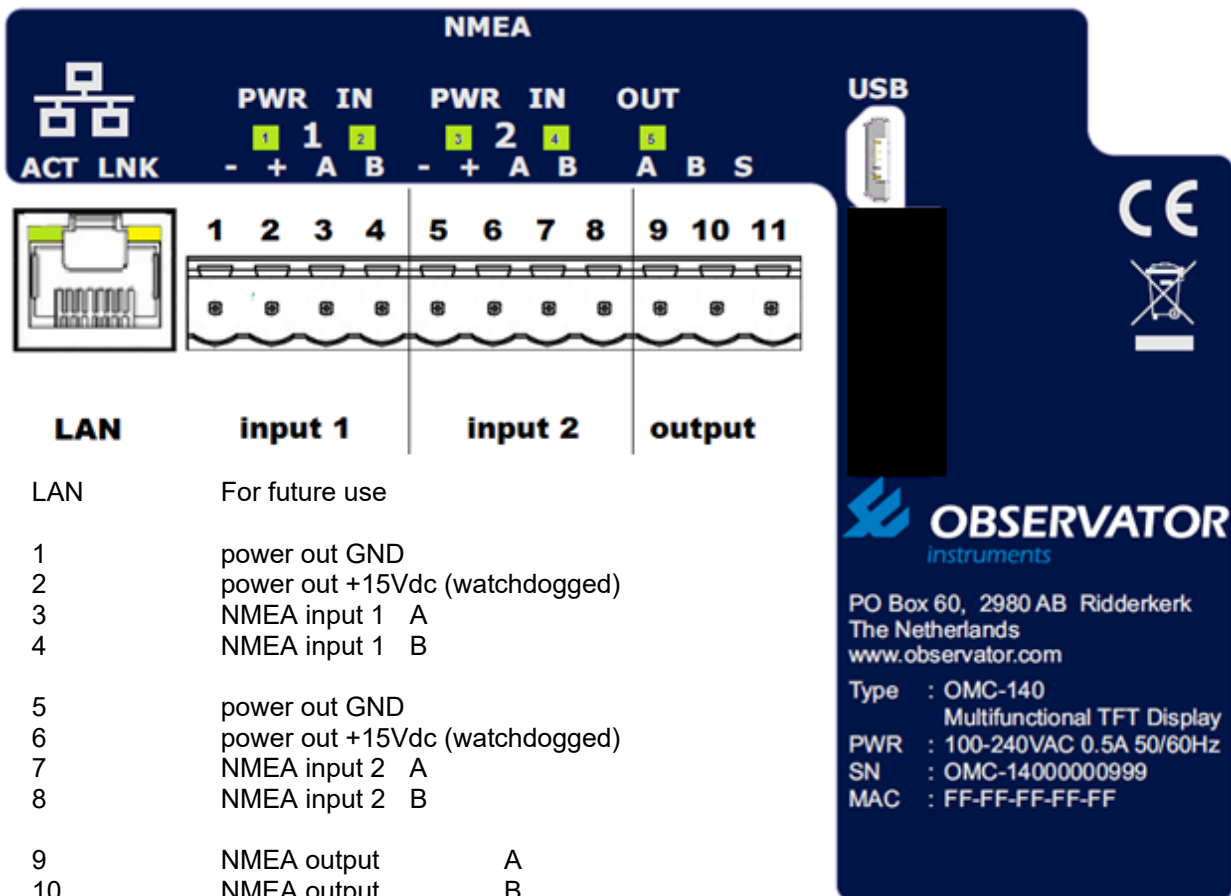

NMEA		PWR IN		PWR IN		OUT				
ACT LNK		1	2	3	4	5				
		-	+	-	+	A	B	A B S		
1	2	3	4	5	6	7	8	9	10	11
LAN		input 1		input 2		output				

**LAN** For future use  
 1 power out GND  
 2 power out +15Vdc (watchdogged)  
 3 NMEA input 1 A  
 4 NMEA input 1 B  
 5 power out GND  
 6 power out +15Vdc (watchdogged)  
 7 NMEA input 2 A  
 8 NMEA input 2 B  
 9 NMEA output A  
 10 NMEA output B  
 11 Output shield connection\*  
**USB** Micro USB connection for advanced programming and firmware updates.  
**LED** Function  
 1 Power input 1  
 2 Data input 1  
 3 Power input 2  
 4 Data input 2  
 5 Data output

**OBSERVATOR instruments**  
 PO Box 60, 2980 AB Ridderkerk  
 The Netherlands  
 www.observator.com  
 Type : OMC-140  
 Multifunctional TFT Display  
 PWR : 100-240VAC 0.5A 50/60Hz  
 SN : OMC-14000000999  
 MAC : FF-FF-FF-FF-FF

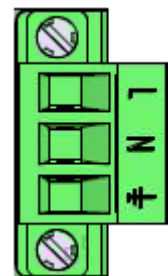

100 .. 240 VAC  
Power  
Connector

**\*Shield connection is for output only, input shield should never be connected to the display!**

### 5.3 AC Connection

The OMC-140 Display accepts AC voltages in the range of 100 .. 240VAC @ 45 .. 65 Hz. The connection is meant for panel mount installations.

**Note: For installations where the AC Mains connection is accessible the optional connector cover must be installed!**

### 5.4 DC power module connections (optional)

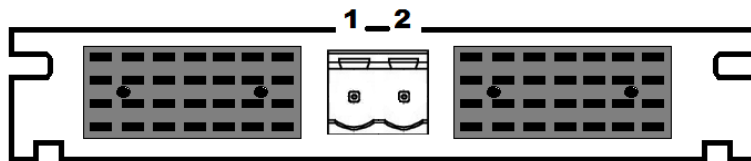

DC power

- 1 GND
- 2 Power +9...+30VDC

### 5.5 Remote keypad and relay module (optional)

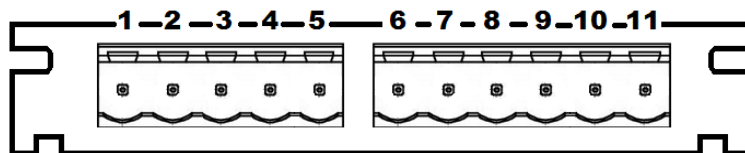

Left Connector

- 1 .. 5 Remote Keypad

Right connector: Relay outputs

- 6 Relay 1 NO contact
- 7 Relay 1 Common
- 8 Relay 1 NC contact
- 9 Relay 2 NO contact
- 10 Relay 2 Common
- 11 Relay 2 NC contact

## 5.6 Connections

Connect the data cable(s) for input and output if required.  
Connect the keypad (if applicable).

Finally connect the power cable.  
If the AC connector is used

Details of the terminal connection can be found in the next chapter.

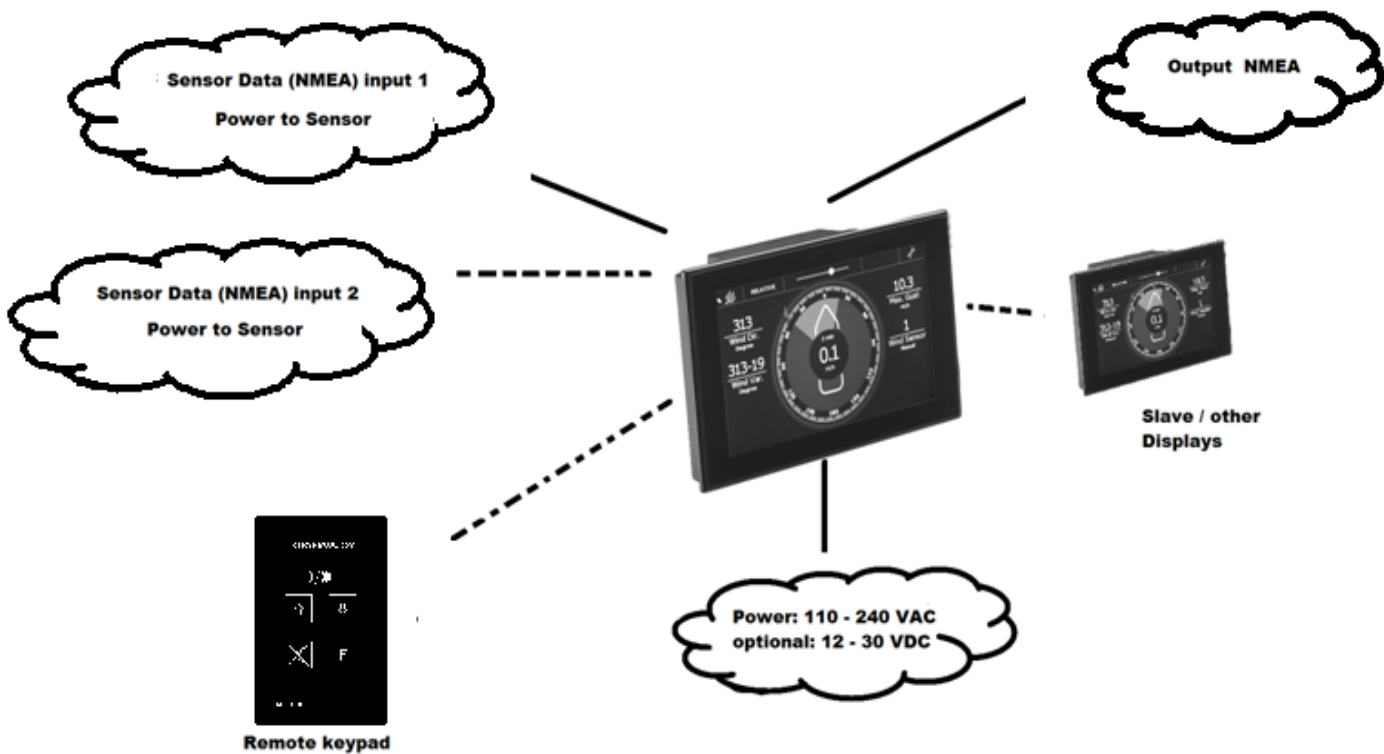

Connection overview

## 6 Commissioning

### 6.1 Preparations

Normal configuration can be done via the touch screen, alternatively this can be done via terminal or by loading a configuration from a micro SD card\*

The display has an auto configuring function: it will makes functions available based on recognized NMEA 0183 messages.

To fully use the auto configure function all inputs should be connected and operational.

*\* the SD card is optional, if fitted the configuration will be stored every 24h or whenever the configuration has been changed. The configuration file name is config.dat.*

### 6.2 Display Type Selection







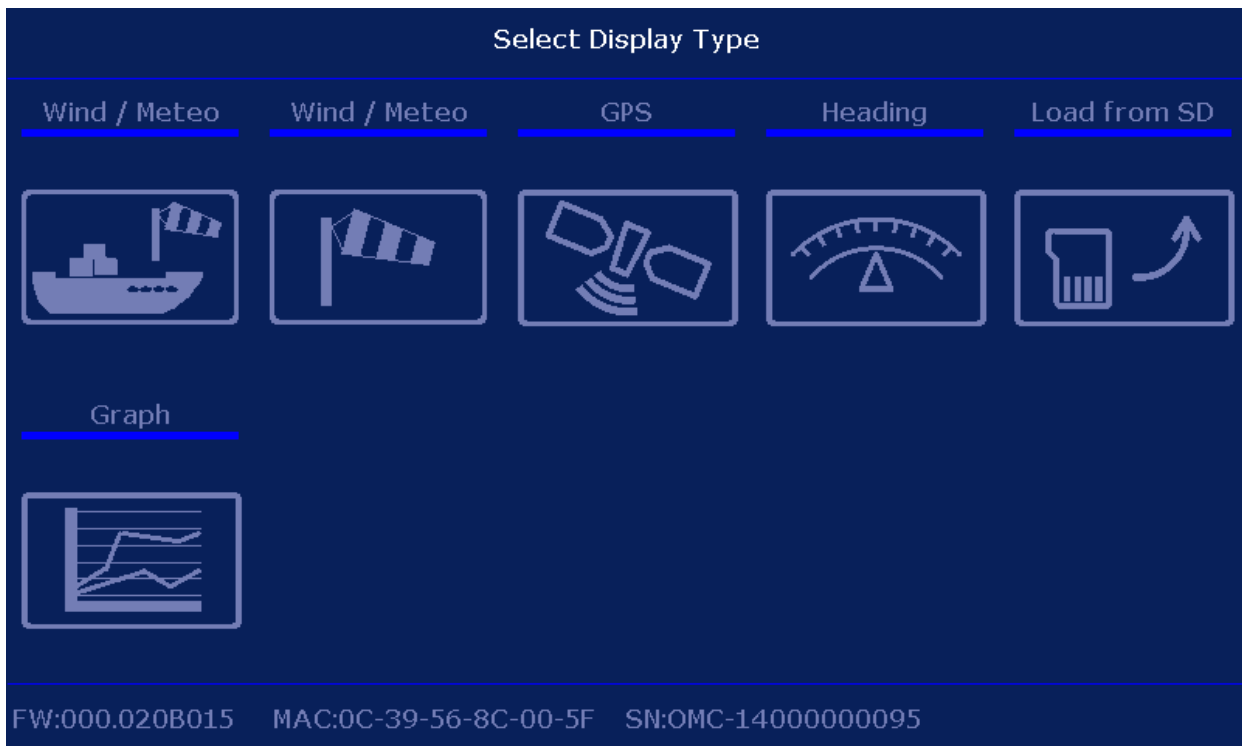

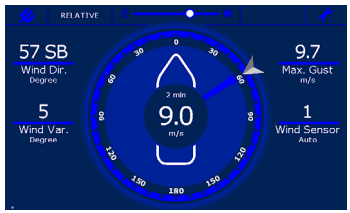

The first time the display is started it will give you the option to select the type.

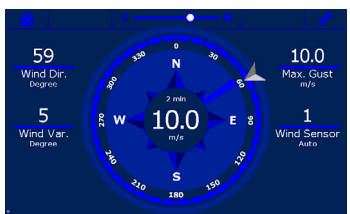
Perform a Factory Reset if the display has been configured before and you want to select a different type.

The Factory Reset is described in paragraph 6.4 Advanced.

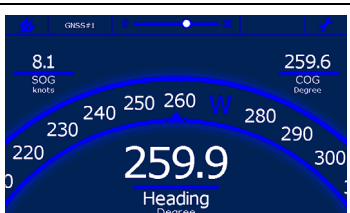

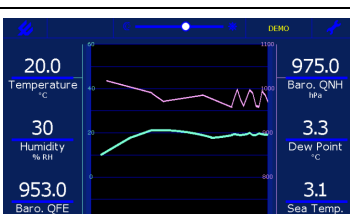
All types can display all accepted NMEA data in decimal format, but each has specific graphics or layout for its purpose:

Symbol	Display type	Specific Features	Front tab
	Marine Wind display	Vessel graphic for Relative & Theoretical wind display  Wind rose graphic for True wind display	
	Land Wind display	Wind rose graphic	
	GPS display	Large position field  Arrow drift display	
	Heading display	Heading and /or Course graphic presentation.	
	Graphical display	Display up to 6 parameters of which 2 graphical.	
	Loads a configuration from the SD card	Filename should be:  config.dat	

### 6.3 Configuration via Touch screen

Once the display type selection has been made and confirmed, the display will start up in the selected type mode.

The display will monitor the inputs and display the data once received.

Default the inputs are set at 4800 baud. If you require 9600 or 19k2 baud, this can be changed via the terminal window accessible via the 'Advanced' menu. This menu has a baud rate scan button and once an input is found the display will auto configure the input for the correct baud rate.

### 6.4 Advanced

The tab 'Advanced' opens with a code panel.

The following default codes are available:

1382	Advanced setting mode (for System Administrator) This password can be changed via advanced menu.
085	Displays the Operator available codes (0851 & 0852)
0851	Opens terminal window input 1
0852	Opens terminal window input 2
0852984	Factory Reset
0851234	Demo mode (for demonstration purposes, enables internal NMEA simulator)

Each code should be followed by [ENTER]

**Note: The first 0 will not be displayed on screen whenever typing a code!**

#### 6.4.1 Advanced password (default 1382)

The 'Advanced' password is default 1382. This can be changed via the advanced tab. This can be useful when you don't want the operator to be able to edit the advanced settings.

Tap 'New Pass'

You will be asked to type the current password.

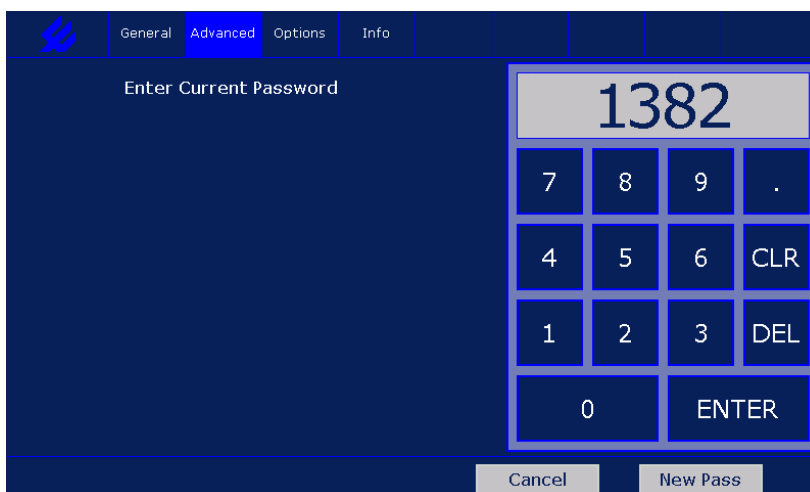

Enter the new password



Confirm password

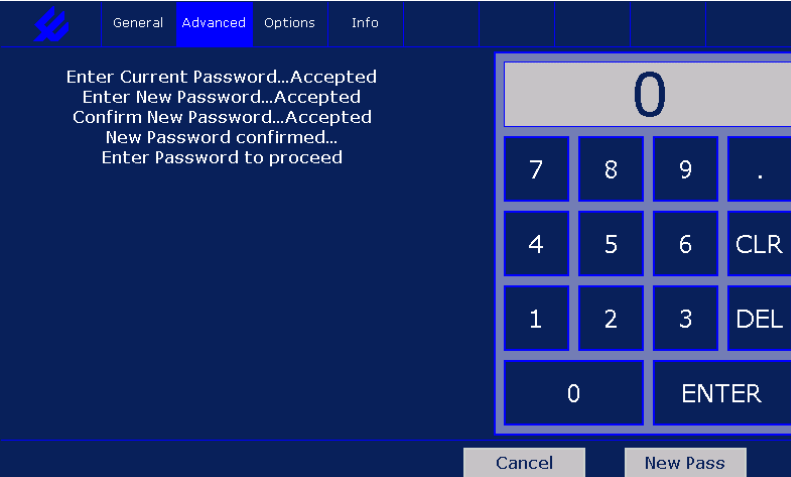

New password confirmed.

Cancel will bring you back to the main screen, for advanced options you will have to enter the new password again.

**Please note: The password can only be reset to default by a Factory Reset if you lose it!**

We will assume your password is 1382 in this manual, if you change it replace 1382 with your own password whenever you follow an example.

## 6.4.2 Advanced settings

Code 1382 opens settings for the System Administrator on the 'Advanced' page, the 'Front' tab and the 'Sensors' tab. After editing use the Save & Exit button to save any changes or Cancel to discard them.

### **a. Advanced - Offset sensor 1 & 2 (Wind only)**

This function sets an offset to the wind direction of the wind sensor. Use this function for lining up the wind sensor to North or Bow without changing the physical wind sensor position.

### **b. Advanced - Display Mode**

Toggles the screen between Landscape (Default) and Portrait mode. The menu will always be in landscape.

Portrait mode has 2 parameter less available on screen compared to Landscape.

### **c. Advanced - Marked Discontinuity**

With Marked Discontinuity set to 'On' the wind data will also be monitored in 2 minute interval whenever 10 minutes is selected. Under the following conditions the display will automatically switch to 2 minute average interval:

1. The difference in wind speed between 2 minute & 10 minute average is equal to or exceeds 10 kn.

OR

2. The average wind speed is (either 10 minute or 2 minute interval) is equal to or exceeds 10 kn AND the difference in wind direction between 2 minute & 10 minute average interval is equal to or exceeds 30 degrees.

OR

3. The difference in wind direction between 2 minute & 10 minute average is equal to or exceeds 60 degrees.

To indicate a Marked Discontinuity has occurred, the 10 minute average will be shown as <10 minute. The < symbol will disappear when there hasn't been a Marked Discontinuity for the next 8 minutes.

### **d. Advanced- Wind Alarm**

Enable or disables Wind Alarm settings.

Wind Alarm settings can be altered when the Wind Alarm is set to On, otherwise it will be grayed out.

The following parameters can be set:

1. Wind Alarm level
2. Pre Alarm (value may not exceed Wind Alarm value)
3. Hysteresis
4. Alarm Delay

### **The alarm is triggered by the actual value of the wind speed!**

Operator averaging display settings will not have any influence on the trigger value of this alarm.

The alarm function works as follows:

1. The actual wind speed will be used for triggering the alarm (which is basically the gust).
2. You can set a wind speed end- and pre-alarm value.
3. You can set a hysteresis and delay, both will be set identical for pre and end alarm.
4. Delay is set in seconds. The wind speed will need to be above the set alarm value for the set delay time before it is triggered.
5. Hysteresis is set in wind speed and work when the wind speed goes below the set value.

6. The interval setting (instant /user / 2 & 10 minute average) will not influence the alarm behavior.
7. When an alarm situation is reached:
  - the beeper will be activated and the display will show (pre) alarm.
  - The beeper will sound until it is accepted (by touching the alarm message or pressing the accept button on the optional remote controller.).
  - The alarm message will remain until the wind speed is below the set alarm value (minus hysteresis).
8. The optional relay output can be set in 2 modes (only accessible via micro USB terminal menu):
  - 1 (default)                   It follows the display beeper  
Once accepted it will be deactivated.  
Useful when an alarm horn is directly connected.
  - 2                                It follows the actual alarm status  
Acceptance on the display does not influence the status.  
Useful when connected to a 3<sup>rd</sup> party system (plc etc.).

*Example:*

*Alarm level:     20 m/s*  
*Pre Alarm:     15 m/s*  
*Hysteresis:     1 m/s*  
*Delay:         10s*

*The Pre Alarm will be high when the actual wind speed is over 15m/s for at least 10s.*  
*The Alarm will be high when the actual wind speed is over 20 m/s for at least 10s.*  
*The Alarm will be low when the actual wind speed is below 19 m/s.*  
*The Pre Alarm will be low when the actual wins speed is below 14 m/s.*

### 6.4.3 Front (Screen layout)

Within certain limits it is possible to customize the screen layout.

In Wind mode 6 data fields - 3 left and 3 right of the wind circle – can be altered (in portrait mode this is limited to 4).

In GPS mode 4 lower data fields can be edited.

In Heading mode only the 2 upper fields can be edited.

The fields can be chosen from the available data.



Tap on a parameter location to toggle through the available parameter options.

**Due to the long list of possible options, the display will default only show available parameters based on received data!**

### 6.4.4 Enabling parameters without the actual data

If you do want to preconfigure the screen layout without any sensor data, you can enable data messages via the USB terminal mode:

See chapter 7 Terminal Mode Configuration how to connect and enter the menu.

Navigate to:

1. Device settings
  1. Display intensity
  2. Sensor 1
  3. Sensor 2

If you already know to which port you will connect select the corresponding sensor port.  
Otherwise simply open sensor 1.  
Change the status of the required data from 'Auto' to 'On'

Installation Settings Sensor 1:

- |   |                      |        |
|---|----------------------|--------|
| 1 | Baudrate             | (4800) |
| 2 | Watchdog             | (ON)   |
| 3 | MWV Relative         | (AUTO) |
| 4 | MWV Theoretical      | (AUTO) |
| 5 | MWD True             | (AUTO) |
| 6 | GGA GPS Quality      | (AUTO) |
| 7 | VTG GPS Ship Heading | (AUTO) |
| 8 | HDT/THS Gyro Heading | (AUTO) |
| 9 | VHW Log Speed        | (AUTO) |
| A | XDR Data             | (AUTO) |
| B | SWS200 Weather       | (AUTO) |
| C | GMP GPS Data         | (AUTO) |
| D | GST GPS Data         | (AUTO) |
| 0 | Previous Menu        |        |

Once finished leave the menu and save the changes (type 0 until you are asked to save / discard settings, then choose 1 to save).

If you open the 'Front' tab now you should be able to toggle through the parameters corresponding the enabled data.  
Once finished use 'Save & Exit' to store your layout.

If you enabled the correct data messages for the correct Sensor ports you are done. But if you are not sure to which Sensor port the data will be sent you will have to change all Data messages set to 'On' back to 'Auto' to be save. The display monitors for the expected data and will give a Sensor 1 or 2 warning whenever expected data (=data set to 'On') is missing.

**If you need to configure multiple displays similar, configure first 1 display completely and place a micro SD card (2GB).  
Go to the settings menu and choose Save & Exit.**

**The configuration will be stored on the SD card as config.dat.**

**You can use this SD card in all the other displays to load the configuration via the Select Display Type menu (see 6.2)**

## 6.4.5 Sensors

This tab shows the VER data of connected sensors.

---

## 7 Terminal Mode Configuration

More advanced settings can be done in terminal mode via the micro USB port.

You will need to install the correct USB driver first. This can be downloaded from our website:

[http://www.observatormeteohydro.com / support / software](http://www.observatormeteohydro.com/support/software)

You will need a terminal program like **OMC-terminal** which can also be downloaded from above page, but you are free to use any other terminal program.

Unzip and install the driver.

After installation connect the USB cable to the display and your pc.

Start the terminal program, settings:

Select right com port

9600 baud

8 bits

No parity

1 stop bit

No Flow control

Once connected type: **menu [Enter]**

The following menu should appear:

**Main Menu:**

- 1 Device Settings**
- 2 Wind Settings**
- 3 GPS Settings**
- 4 Heading Settings**
- 0 Exit Menu**

You can find the full menu structure in [chapter 14](#) Menu Structure Terminal Mode

## 8 Terms, Abbreviations & Symbols list

### 8.1 Terms & Abbreviations

Advanced	Advanced menu protected by password
Average	Interval over which the average wind speed & direction is calculated
Dimming Control	Selected means of regulation of the backlight
Options	Option slot information
QFE	Barometric Pressure at Runway Level
QNH	Barometric Pressure at Sea level
Relative	Wind direction & speed as measured.
Sensor 1	Sensor connected to port 1 of the display
Sensor 2	Sensor connected to port 2 of the display
True	True wind direction & speed related to True North
Theoretical	Wind direction & speed as if the vessel would not move, related to the bow of the vessel.
Wind Variation	The variation in wind direction over the selected Average interval.

### 8.2 Symbols



Select between Day or Night mode.  
 In Night mode a darker color palette reduces the emitted light intensity.



Brightness slider bar.  
 In Automatic or NMEA control mode; use this to set an offset.



Settings menu

---

## 9 Digital interface

### 9.1 NMEA software

#### 9.1.1 Inputs:

The Display accepts the following NMEA input messages with a maximum rate of 4 per second:

\$xxDDC	Dimming control of backlight
\$xxGGA	GPS Lon Lat position
\$xxGMP	GNSS Map Projection Fix Data
\$xxGST	GNSS Pseudo range Error Statistics
\$xxHDT	Heading from Gyro (replaced by \$xxTHS, display accepts both)
\$xxMWD	True Wind
\$xxMWV	Relative or Theoretical Wind
\$xxTHS	Heading from Gyro
\$xxVER	Version info
\$xxVHW	Speed through water (direction is not used)
\$xxVTG	Speed and direction over ground
\$xxXDR	Air Temperature, Sea Temperature, Humidity, Dew point, Barometric Pressure (measured), Barometric Pressure QNH (Sea level), Barometric Pressure QFE (Runway level)

Retired sentences (sentences not recommended for new designs since 2008):

\$xxMDA	Meteorological Composite
\$xxMHU	Humidity
\$xxMMB	Barometer
\$xxMTA	Air Temperature

#### 9.1.2 Outputs:

All recognized input messages (except the retired NMEA sentences) can be copied to the output

Calculated messages

\$xxMWV	Relative or Theoretical Wind
\$xxMWD	True Wind

Other functions

\$xxDDC	Dimming control of backlight
\$xxVER	Version info

## 9.2 NMEA Message description

\$--DDC,a,xx,a,a\*hh<CR><LF>  
           1  2  3  4

1. Sentence Status Flag
2. Color palette
3. Brightness percentage 00 to 99
4. Display dimming preset

\$--GGA,hhmmss.ss,llll.ll,a,yyyyy.yy,a,x,xx,x.x,x.x,M,x.x,M,x.x,xxxx\*hh<CR><LF>  
           1      2      3      4  5  6      7      8      9     10

1. UTC of position
2. Latitude - N/S
3. Longitude - E/W
4. GPS Quality indicator<sub>1</sub>
5. Number of satellites in use, 00-12, may be different from the number in view
6. Horizontal dilution of precision
7. Altitude re: mean-sea-level (geoid), meters
8. Geoidal separation, meters
9. Age of Differential GPS data
10. Differential reference station ID, 0000-1023

\$--GMP,hhmmss.ss,c--c,c--c,x.x,x.x,c--c,xx,x.x,x.x,x.x,x.x,x.x,a\*hh<CR><LF>  
           1      2      3      4  5      6  7      8  9     10 11 12 13

1. UTC of position
2. Map projection identification
3. Map zone
4. X (Northern) component of grid (or local) coordinates
5. Y (Eastern) component of grid (or local) coordinates
6. Mode indicator
7. Total number of satellites in use, 00-99
8. HDOP
9. Antenna altitude, meters, re: mean-sea-level (geoid)
10. Geoidal separation, meters
11. Age of differential data
12. Differential reference station ID
13. Navigational Status Indicator

\$--GST,hhmmss.ss,x.x,x.x,x.x,x.x,x.x,x.x,x.x\*hh<CR><LF>  
           1      2      3      4      5      6      7      8

1. UTC time of the GGA or GNS fix associated with this sentence.
2. RMS value of the standard deviation of the range inputs to the navigation process. Range inputs include pseudoranges & DGNS corrections.
3. Standard deviation of semi-major axis of error ellipse (meters)
4. Standard deviation of semi-minor axis of error ellipse (meters)
5. Orientation of semi-major axis of error ellipse (degrees from true north)
6. Standard deviation of latitude error (meters)
7. Standard deviation of longitude error (meters)
8. Standard deviation of altitude error (meters)

\$--HDT,x,x,T\*hh<CR><LF>  
           1  2

1. Heading
2. degrees True (fixed)

\$--MWD,x,x,T,x,x,M,x,x,N,x,x,M\*hh<CR><LF>  
           1    2    3    4

1. Wind direction, 0 to 359 degrees True
2. Wind direction, 0 to 359 degrees Magnetic
3. Wind speed, knots
4. Wind speed, meters/second

\$--MWV,x,x,a,x,x,a,A\*hh<CR><LF>  
           1  2  3  4  5

1. Wind angle, 0 to 359 degrees
2. Reference:  
           R = Relative  
           T = Theoretical
3. Wind speed
4. Wind speed units: K/M/N/S
5. Status, A = Data Valid, V = Data invalid

\$--THS,x,x,a\*hh<CR><LF>  
           1  2

1. Heading, degrees True
2. Mode indicator:  
           A = Autonomous  
           E = Estimated (dead reckoning)  
           M = Manual input  
           S = Simulator  
           V = Data not valid (including standby)  
           This field shall not be null.

\$--VER,x,x,aa,c--c,c--c,c--c,c--c,c--c,c--c,x\*hh<CR><LF>  
           1  2  3  4  5  6  7  8  9  10

1. Total number of sentences needed, 1 to 9
2. Sentence number, 1 to 9
3. Device type
4. Vendor ID
5. Unique Identifier
6. Manufacturer serial number
7. Model code (product code)
8. Software revision
9. Hardware revision
10. Sequential message identifier

\$--VHW,x,x,T,x,x,M,x,x,N,x,x,K\*hh<CR><LF>  
           1    2    3    4

1. Heading, degrees True
2. Heading, degrees Magnetic
3. Speed, knots
4. Speed, km/hr

\$--VTG,x.x,T,x.x,M,x.x,N,x.x,K,a\*hh<CR><LF>  
           1      2      3      4  5

1. Course over ground, degrees True
2. Course over ground, degrees Magnetic
3. Speed over ground, knots
4. Speed over ground, km/hr
5. Mode Indicator:
  - A = Autonomous mode
  - D = Differential mode Corrections from ground stations or Satellite Based Augmentation System (SBAS).
  - E = Estimated (dead reckoning) mode
  - M = Manual input mode
  - N = Data not valid
  - P = Precise. Satellite system used in precision mode. Precision mode is defined as no deliberate degradation ( such as selective availability) and higher resolution code (P-code) is used to compute position fix. P is also used for satellite system used in multi-frequency, or Precise Point Positioning (PPP) mode
  - S = Simulator mode

This Mode Indicator field shall not be a null field.

\$--XDR,a,x.x,a,c--c,.....a,x.x,a,c--c\*hh<CR><LF>  
           1  2  3  4      5      6

1. Transducer type, Transducer #1
2. Measurement data, Transducer #1
3. Units of measure, Transducer #1
4. Transducer #1 ID
5. Data for variable # of transducers
  
6. Transducer 'n'1

Recognized XDR messages:

Parameter	1	2	3	4	remarks
Temperature (Celsius)	C	xx.x	C		4 <> WATER or DP
Humidity (Relative in %)	H	xx	P		4 = ignored
Dewpoint (Celsius)	C	xx.x	C	DP	
Barometric pressure (Bar)	P	xx.x	B		4 <> QNH or QFE
Barometric pressure QNH (Bar)	P	xx.x	B	QNH	
Barometric pressure QFE (Bar)	P	xx.x	B	QFE	
Water temperature (Celsius)	C	xx.x	C	WATER	

The OMC-140 multifunctional display will also accept the following retired sentences:

**Note: These messages will only be used for display and not forwarded to the output!**

\$--MDA,x.x,I,x.x,B,x.x,C,x.x,C,x.x,x.x,x.x,C,x.x,T,x.x,M,x.x,N,x.x,M\*hh<CR><LF>  
           1      2      3      4      5      6      7      8      9      10    11

1. Barometric pressure, inches of mercury \*
2. Barometric pressure, bars \*
3. Air temperature, degrees C
4. Water temperature, degrees C
5. Relative humidity, percent
6. Absolute humidity, percent
7. Dew point, degrees C
8. Wind direction, degrees True
9. *Wind direction, degrees Magnetic ----will not be used!*
10. Wind speed, knots \*\*
11. Wind speed, meters/second \*\*

\* *Barometric Pressure in 'mercury' will only be read when in 'Bar' is not available and will be displayed in the equivalent value in hPa.*

\*\* *Wind speed in knots will only be read when Wind speed in m/s is not available.*

\$--MHU,x.x,x.x,x.x,C\*hh<CR><LF>  
           1      2      3

1. Relative humidity, percent
2. Absolute humidity, percent
3. Dew point, degrees C

\$--MMB,x.x,I,x.x,B\*hh<CR><LF>

1. Barometric pressure, inches of mercury
2. Barometric pressure, bars

\$--MTA,x.x,C\*hh<CR><LF>

1. Temperature, degrees C

## 10 NMEA Hardware:

Input circuit (simplified)

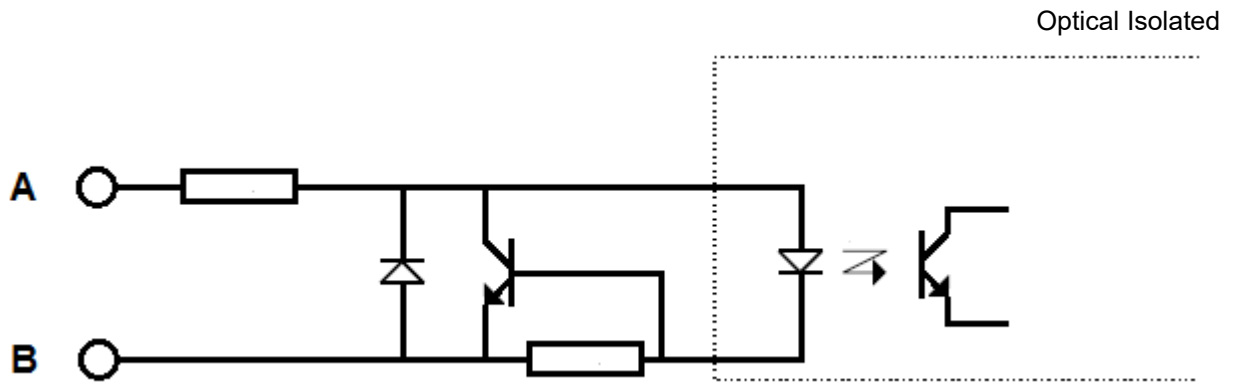

Output circuit (simplified)

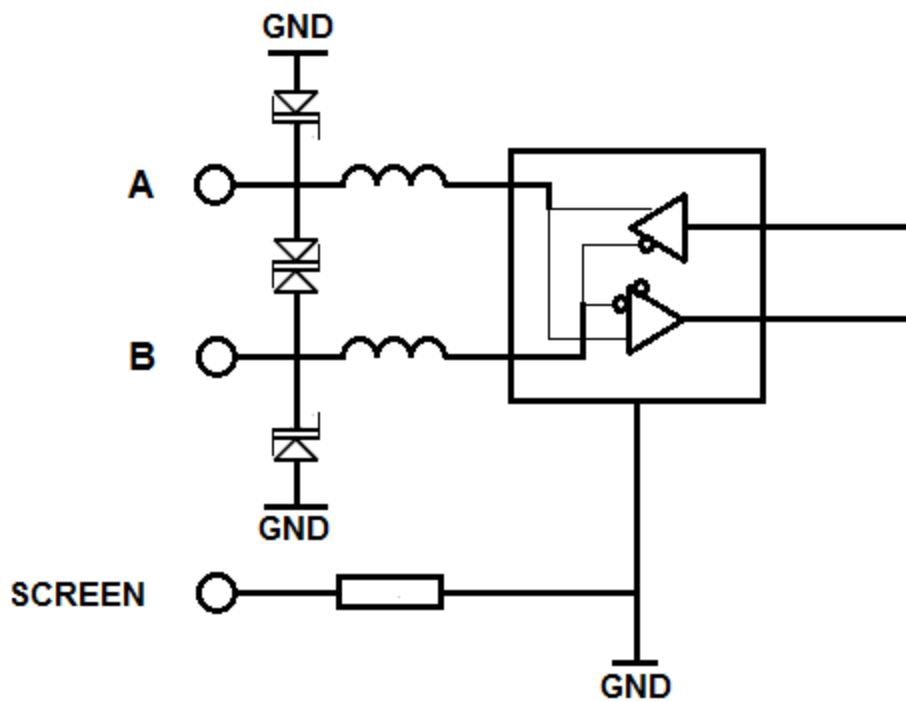

---

## 12 Specifications

### 12.1 Inputs/Outputs

- 2 NMEA0183 inputs
- 1 NMEA0183 output
- Micro USB (programming purposes)
- RJ45 LAN connector (Future use)
- Display interconnection bus

More I/O possible through the option boards

### 12.2 TFT touch screen

- 8,5" Super Wide Viewing Angle 170° LCD with long life and low power LED backlight
- Active display area: 184.8 x 110.9 mm
- Resolution: WVGA 800x480

### 12.3 Electrical

- 100..240 VAC, 50/60 Hz, max 50 VA
- 9-30V Vdc via Optional DC Power Module
- Sensor 1 and 2 power output 15..16.5 Vdc max 1.5 W
- Connections, pluggable screw terminals for max 2.5 mm<sup>2</sup>

### 12.4 Environmental specifications

- Operating temperature –15°C..+55°C
- Storage temperature –30°C..+80°C
- Humidity: 10..93 %RH
- Vibration: IEC 60068-2-6 test Fc
- EMC: IEC 60945; IEC 61326-1
- IP rating: IP22 when fully flush mounted (228 x 142mm)

### 12.5 Dimming possibilities

- From 0,5..700 cd/m<sup>2</sup>
- Day and night pallet selectable
- Manual by means of 'slider bar'
- Automatic by means of ambient light sensor
- Central by means of NMEA DDC input

### 12.6 Dimensions

- Packing 30 x 30 x 40 cm
- Weight 1.2 kgs (excl packing)
- Weight 3 kgs (incl packing & mounting materials)

## 12.7 Alarms

- Build-in alarms on parameters and system functioning
- Outputs, potential free relay outputs through optional OMC-140-2 module

## 12.8 In accordance with

- DNV Standard for Certification No. 2.4
- EMC Directive 2014/30/EU
- LV Directive 2014/35/EU
- RoHS-2 Directive 2011/65/EU
- EMC: ESD IEC 61000-4-2; Radiated Immunity IEC 61000-4-3; Conducted Immunity IEC 61000-4-6; Fast Transients IEC 61000-4-4; Surge IEC 61000-4-5
- Electrical safety: IEC 61010:2010
- NMEA 0183 version 4.10 / IEC 61162-1:2010
- IEC 62288:2008 Draft IEC 62288:2012
- All relevant IMO resolutions
- WMO / ICAO / CAP

## 12.9 Cable specs remote & relay outputs:

- Relay outputs:

Cable length maximum:	30 meter
Cable type AC:	Shielded (single ended)
Cable type DC:	Shielded (twisted pair)
Advised	0.75 mm <sup>2</sup>
Min	0.75 mm <sup>2</sup>
Max	2.50 mm <sup>2</sup>
- Remote input:

Cable length maximum:	30 meter
Cable type:	Shielded (single ended)
Advised:	0.75 mm <sup>2</sup>
Min:	0.25 mm <sup>2</sup>
Max:	2.50 mm <sup>2</sup>

---

## 13 Menu structure Touch screen



Opens settings menu

### General

Dimming Control:

Manual  
Automatic  
NMEA DDC

Sensor selection:

Auto  
Sensor 1  
Sensor 2

Average *(Wind only)*

10 minute  
2 minute  
Instant  
User (settings from User Average Interval)

Wind Speed *(Wind only)*

Bft  
Mph  
m/s  
kn  
km/h

Wind Reference *(Wind only)*

Relative  
Theoretical  
True

User Average Interval *(Wind only)*

Wind Speed  
Wind Direction  
Gust  
Wind Variation

## Advanced

### Keypad

085	Shows Operator available codes'
0851	Terminal input 1
0852	Terminal input 2
0851234	Demo Mode
0852984	Factory reset
1382	Advanced Mode

Offset Sensor 1 *(Wind only)*

Offset Sensor 2 *(Wind only)*

### Display Mode

Landscape  
Portrait

Marked Discontinuity (On / Off) *(Wind only)*

Wind Alarm (On / Off) *(Wind only)*

Wind Alarm (settings) *(Wind only)*

Wind Alarm  
Pre Alarm  
Hysteresis  
Alarm Delay

### Output Baudrate

4800  
9600  
19200  
38400

### Secure User Items

Average	(un)lock	<i>(Wind only)</i>
Wind Speed	(un)lock	<i>(Wind only)</i>
Dimming Control	(un)lock	
Sensor Selection	(un)lock	
Wind Reference	(un)lock	<i>(Wind only)</i>

System Name *(GPS only)*

Edit GPS names *(GPS only)*

## Options

Displays installed option boards

## Info

Displays System & Product info.

**Front** *(only visible in Advanced Menu)*

Edit data fields in Front screen

**Sensors** *(only visible in Advanced Menu)*

NMEA VER Message Table

## 14 Menu Structure Terminal Mode

### Main Menu:

#### 1 Device Settings

- 1 Display Intensity (ON)
  - 1 ON
  - 2 OFF
  - 3 NMEA DDC

#### 2 Sensor 1

*Installation Settings Sensor 1:*

- |   |                     |         |                       |
|---|---------------------|---------|-----------------------|
|   |                     |         | <i>Watchdog Time</i>  |
| 1 | <i>Baud rate</i>    |         | <i>(4800)</i>         |
|   |                     | 1 4800  |                       |
|   |                     | 2 9600  |                       |
|   |                     | 3 19200 |                       |
| 2 | <i>Watchdog</i>     |         | <i>(ON)</i>           |
| 3 | <i>MWV Relative</i> |         | <i>(ON) ( 10) sec</i> |

*Turn MWV Relative message (2) AUTO / (1) ON / (0) OFF: 1*

*Watchdog time in seconds (No value = 10 sec):*

- 4 *MWV Theoretical* (AUTO)
- 5 *MWD True* (AUTO)
- 6 *GGA GPS Quality* (ON) ( 10) sec
- 7 *VTG GPS Ship Heading* (ON) ( 10) sec
- 8 *HDT/THS Gyro Heading* (AUTO)
- 9 *VHW Log Speed* (AUTO)
- A *XDR Data* (ON) ( 10) sec
- B *SWS200 Weather* (AUTO)
- C *GMP GPS Data* (AUTO)
- D *GST GPS Data* (AUTO)
- E *MHU GPS Data* (AUTO)
- F *MMB GPS Data* (AUTO)
- G *MTA GPS Data* (AUTO)
- H *MDA GPS Data* (AUTO)
- 0 *Previous Menu*

#### 3 Sensor 2

*Installation Settings Sensor 2:*

- |   |                     |         |                      |
|---|---------------------|---------|----------------------|
|   |                     |         | <i>Watchdog Time</i> |
| 1 | <i>Baudrate</i>     |         | <i>(4800)</i>        |
|   |                     | 1 4800  |                      |
|   |                     | 2 9600  |                      |
|   |                     | 3 19200 |                      |
| 2 | <i>Watchdog</i>     |         | <i>(ON)</i>          |
| 3 | <i>MWV Relative</i> |         | <i>(AUTO)</i>        |

*Turn MWV Relative message (2) AUTO / (1) ON / (0) OFF: 1*

*Watchdog time in seconds (No value = 10 sec):*

- 4 *MWV Theoretical* (AUTO)
- 5 *MWD True* (AUTO)
- 6 *GGA GPS Quality* (AUTO)
- 7 *VTG GPS Ship Heading* (AUTO)
- 8 *HDT/THS Gyro Heading* (AUTO)
- 9 *VHW Log Speed* (AUTO)
- A *XDR Data* (AUTO)
- B *SWS200 Weather* (AUTO)
- C *GMP GPS Data* (AUTO)
- D *GST GPS Data* (AUTO)
- E *MHU GPS Data* (AUTO)
- F *MMB GPS Data* (AUTO)
- G *MTA GPS Data* (AUTO)
- H *MDA GPS Data* (AUTO)
- 0 *Previous Menu*

4 Output

5 Extention Board Settings

- 1 *Invert Alarm Relais* (DISABLED)
- 2 *Follow (Wind) Alarm State* (DISABLED)

6 Upload Firmware (Y-modem)

## 2 Wind Settings

Menu Wind:

- 1 Average (Instant)
  - 1 *Instant*
  - 2 *2 Minutes*
  - 3 *10 Minutes*
  - 4 *User Defined*
  - 5 *Set User Defined Interval*
- 2 Wind Speed Units (kn)
  - 1 *Bft*
  - 2 *Mph*
  - 3 *m/s*
  - 4 *kn*
  - 5 *Km/h*
- 3 Sensor Selection (Automatic)
  - 1 *Automatic*
  - 2 *Sensor 1*
  - 3 *Sensor 2*
- 4 Wind Reference (True)
  - 1 *Relative*
  - 2 *Theoretical*
  - 3 *True*
- 5 Offset Sensor 1 (0 degree)
- 6 Offset Sensor 2 (0 degree)
- 7 Wind Alarm (OFF)
  - 1 *Pre Alarm* (10.0 m/s)

- 2 *Wind Alarm* (15.0 m/s)
- 3 *Hysteresis* (0.0 m/s)
- 4 *Alarm Delay* (0 sec)
- 5 *Alarm ON/OFF* (OFF)
  
- 8 *Marked Discontinuity* (OFF)
  - 1 *ON*
  - 2 *OFF*
  
- 9 *Max. Deviation of 2 Sensors* (100.0 m/s)
  
- A *Secure User Items*
  - 1 *Average* (UNLOCKED)
  - 2 *Wind Speed* (UNLOCKED)
  - 3 *Auto Display Intensity* (UNLOCKED)
  - 4 *Sensor Selection* (UNLOCKED)
  - 5 *Wind Reference* (UNLOCKED)

### 3 GPS Settings

Menu GPS:

- 1 *Sensor Selection* (Automatic)
  - 1 *Automatic*
  - 2 *Sensor 1*
  - 3 *Sensor 2*
  
- 2 *Front View 1* (LAT/LON)
  - 1 *LAT/LON*
  - 2 *UTM*
  
- 3 *Front View 2* (User Defined)
  - 1 *User Defined*
  - 2 *SOG View*
  
- 4 *Secure User Items*
  - 1 *Dimming Control* (UNLOCKED)
  - 2 *Sensor Selection* (UNLOCKED)
  - 3 *Front View 1* (UNLOCKED)
  - 4 *Front View 2* (UNLOCKED)
  
- 5 *Set Selectable System Names*
  - 1 *GNSS#1*
  - 2 *GNSS#2*
  - 3 *GNSS#3*
  - 4 *GNSS#4*
  - 5 *GNSS#5*
  - 6 *GNSS#6*

## 4 Heading Settings

Menu Heading:

- 1 Sensor Selection (Automatic)
  - 1 *Automatic*
  - 2 *Sensor 1*
  - 3 *Sensor 2*
  
- 2 Front View 1 (Heading)
  - 1 *Course*
  - 2 *Heading*
  
- 3 Secure User Items
  - 1 *Dimming Control* (UNLOCKED)
  - 2 *Sensor Selection* (UNLOCKED)
  - 3 *Front View* (UNLOCKED)
  
- 4 Set Selectable System Names
  - 1 *GNSS#1*
  - 2 *GNSS#2*
  - 3 *GNSS#3*
  - 4 *GNSS#4*
  - 5 *GNSS#5*
  - 6 *GNSS#6*

## 0 Exit Menu

## 15 Dimensional drawings

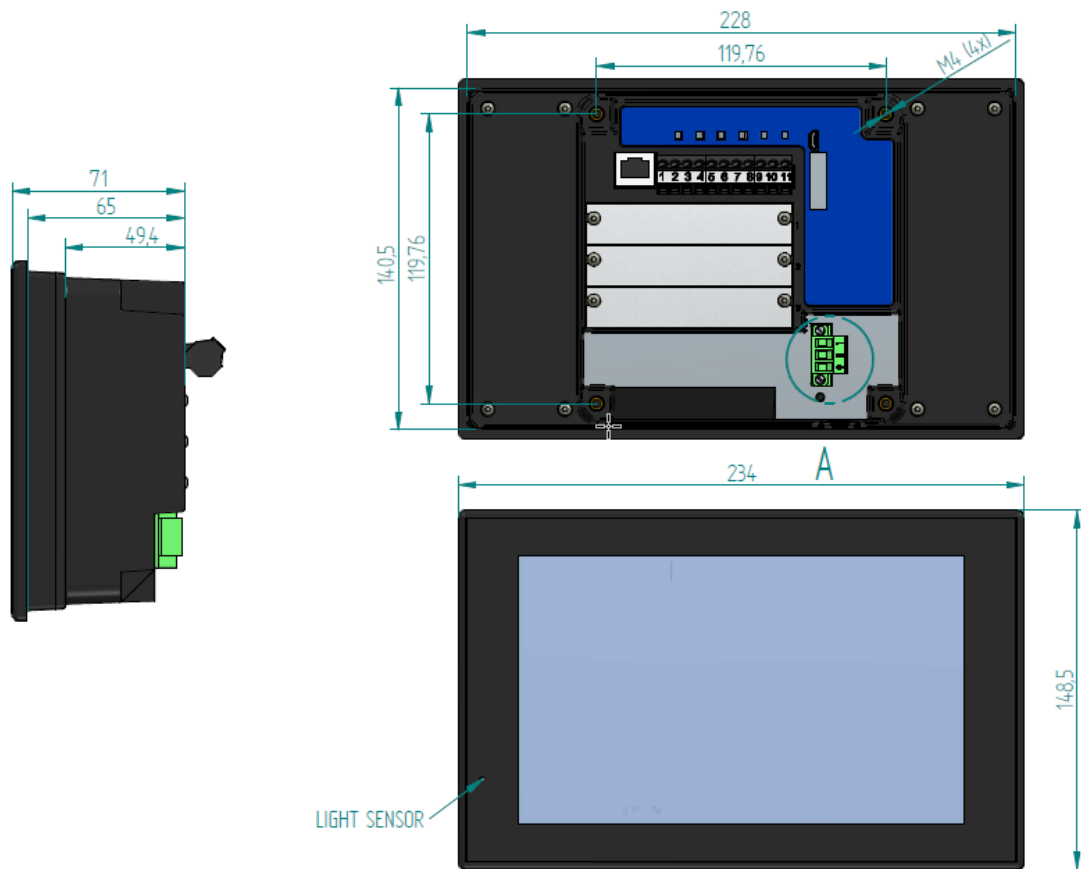

Spacer advised to be used in case of retrofitting into a 144x144 cut-out

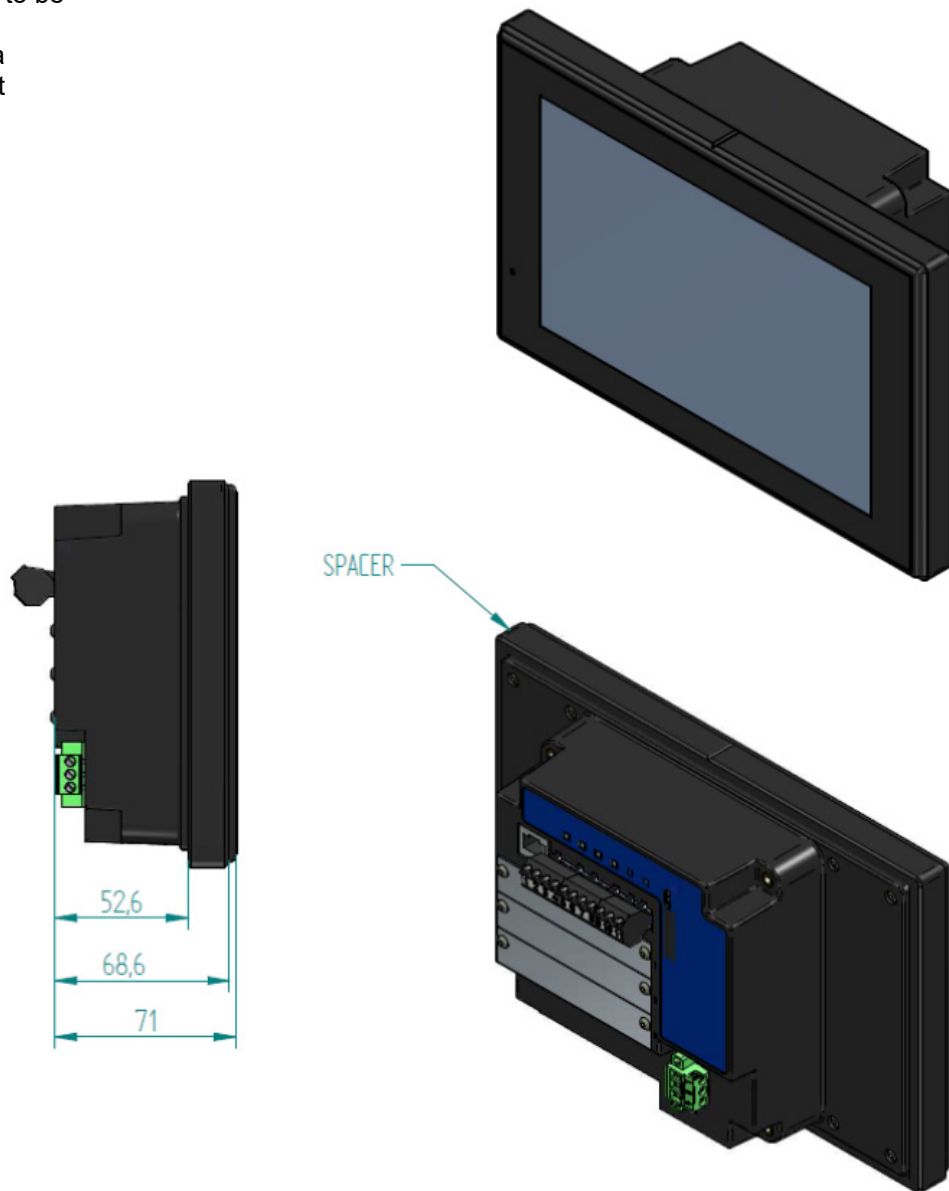

## 16 Panel cut-outs

### 16.1 Recommended panel cut-out

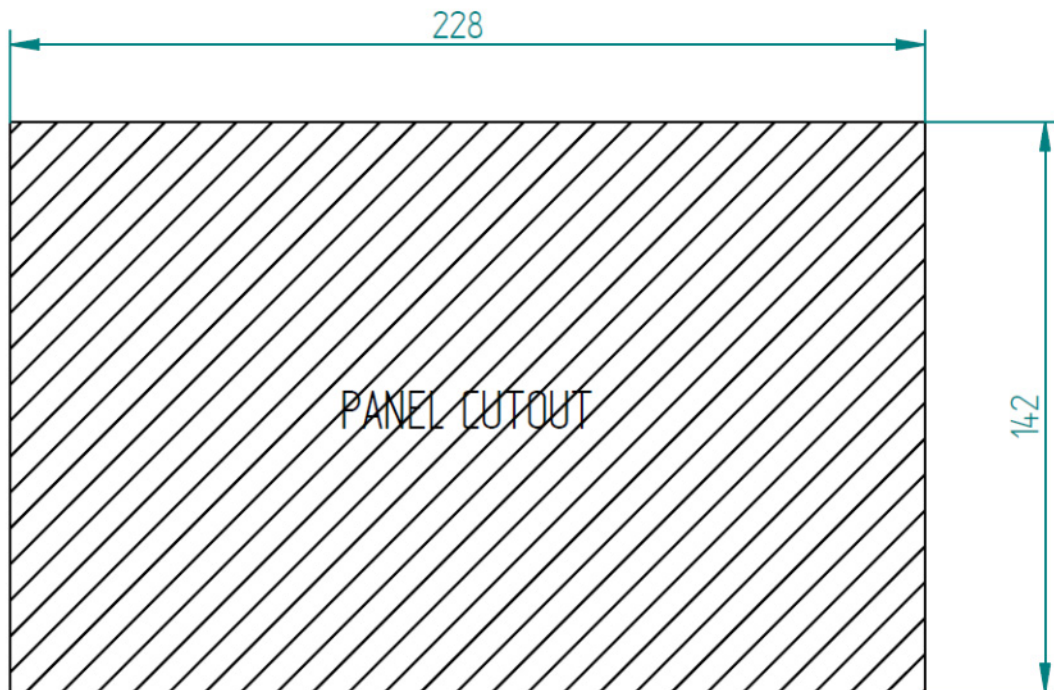

### 16.2 Panel cut-out for retrofit 144x144 instrument

